

# ROVECONCEPTS

Refined Luxury Living

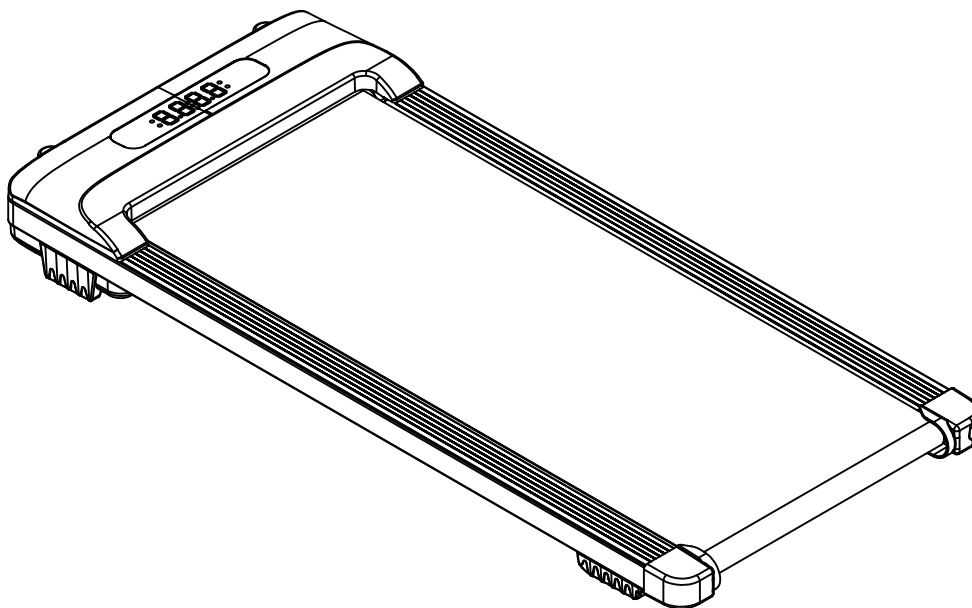

## CAMINO TREADMILL MOTORIZED WALKING PAD MANUAL Manuel du tapis de marche motorisé



READ ALL INSTRUCTIONS CAREFULLY BEFORE INSTALLING AND USING THIS PRODUCT. RETAIN THIS OWNER MANUAL FOR THE FUTURE REFERENCE.

# CONTENTS

SAFETY & CAUTIONS.....	3
ASSEMBLY INSTRUCTION.....	5
ASSEMBLY STEPS.....	5
TECHNICAL SPECIFICATIONS.....	6
GROUNDING INSTRUCTIONS.....	6
EXPLODED VIEW.....	7
EXPLOSION DETAILS.....	8
WARMING-UP.....	9
SAFETY TRAINING MEASURES.....	10
PRODUCT MAINTENANCE.....	10
RUNNING BELT ADJUSTMENT.....	13
OPERATION GUIDE.....	14

## SAFETY PRECAUTIONS

**WARNING:** Before carrying out any exercise program, we suggest that you should first consult a professional doctor, especially those who are over 35 years old or have ever had health problems. We are not responsible for any injury caused by this. After the electric treadmill is completely installed and the motor protection cover is covered, the power can be turned on.

### Attentions

1. Before using the treadmill, make sure that the clip of the safety switch is clamped on the clothes or belt.
2. Please do not insert any other items into any part of the equipment, which will damage the equipment.
3. Put the electric treadmill in a clean and flat place, do not put the electric treadmill on the thick carpet, so as to avoid affecting the air circulation under the electric treadmill, and do not put the electric treadmill in the place near the water or outdoor use.
4. Please do not turn on the machine when you are standing on the running belt. After the power is turned on the running belt may stop when it starts to move. People must stand on the plastic anti-skid boards on both sides of the electric treadmill until the running belt moves.
5. Don't wear too long and loose clothes when exercising, in order to avoid hanging on the electric treadmill. Usually wear running shoes with rubber soles.
6. When the electric treadmill is in use, please keep away from children or pets. There should be 50cm-100cm empty safe operation area around the product.
7. Any strenuous exercise can only be done 40 minutes after a meal.
8. This kind of fitness equipment is used by adults, and minors need to be accompanied by adults when using the electric treadmill.
9. When using the electric treadmill for the first time, you must hold the armrest with your hand until you feel comfortable.
10. The treadmill is an indoor device. Do not use it outdoors. The place should be clean and flat, and attention should be paid to moisture-proof. The electric treadmill should be a special instrument. Do not refit it for other purposes.
11. The power cord of electric treadmill is special. If the power cord is damaged, please buy it from the dealer or contact our company directly.
12. If the speed increase suddenly or inadvertently due to an electronic failure, please pull off the safety lock from the console, then the treadmill will stop.

13. Do not connect other line to the middle of cable; do not lengthen cable or change the cable plug; do not put any heavy thing on cable or put the cable near the heat source; forbid using socket with several holes, these may cause fire or people may be hurt by the power. While insert the plug, pls make sure to Insert it into the socket with the safety ground circuit.
14. When the machine is not used for a long time, the power supply should be cut off. When cutting off the power supply, do not pull the power cord; you must hold the power plug and pull it out, so as not to pull off a part of the core wire of the power line. Insert the power cord plug into the power socket with safety grounding. The power cord of the electric treadmill is special. If the power cord is damaged, please contact the manufacturer as soon as possible.
15. This treadmill is for home use only.
16. Warning of incorrect or excessive exercise may cause health damage
17. Every month, check whether all connecting screws are loose and whether all parts are damaged. If there is any damage, it should be replaced and repaired immediately.

# ASSMBLY

This product is free of installation.

Open the packing box and you can take out the following parts in the box.

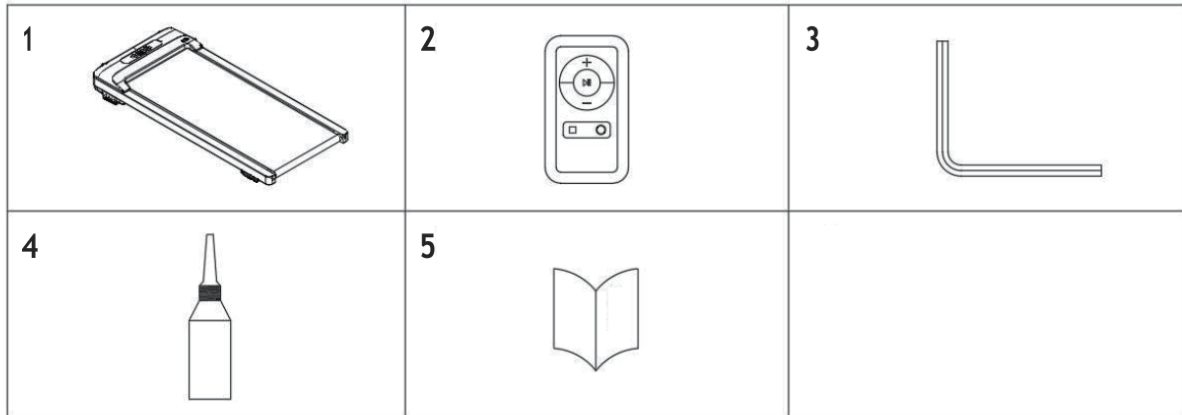

NO.	NAME	PARAMETER	QTY
1.	Treadmill		1
2.	Remote Control		1
3.	Allen Key	S5	1
4.	Silicone Oil	25ml	1
5.	Manual		1

**Step 1:** Take the product out of the packing box, read the instructions carefully, and then power onto use!

## TECHNICAL SPECIFICATIONS

<b>PACKING SIZE(MM)</b>	1380x670x170mm	<b>MOTOR POWER</b>	DC 0.75-2.5HP
<b>RATED VOLTAGE</b>	110V	<b>FREQUENCY (HZ)</b>	60Hz
<b>RUNNING AREA(MM)</b>	1100x450mm	<b>SPEED RANGE</b>	0.6-3.7Mile/h
<b>NET</b>	23.5KG	<b>MAX USER WEIGHT</b>	120KG
<b>LED SCREEN FUNCTION</b>	Speed, Time, Distance, Calories		

## GROUNDING INSTRUCTIONS

This product must be grounded. If it should malfunction or breakdown, grounding provides a path of least resistance for electric current to reduce the risk of electric shock. This product is equipped with a cord having an equipment-grounding conductor and a grounding plug. The plug must be plugged into an appropriate outlet that is properly installed and grounded in accordance with all local codes and ordinances.

**DANGER** - Improper connection of the equipment-grounding conductor can result in a risk of electric shock. Check with a qualified electrician or serviceman if you are in doubt as to whether the product is properly grounded. Do not modify the plug provided with the product - if it will not fit the outlet, have a proper outlet installed by a qualified electrician.

This product is for use on a nominal 110-volt circuit and has a grounding plug that looks like the plug illustrated in sketch A in following figure. Make that the product is connected to an outlet having the same configuration as the plug. No adapter should be used with this product.

# DESCRIPTION OF POWER GROUNDING

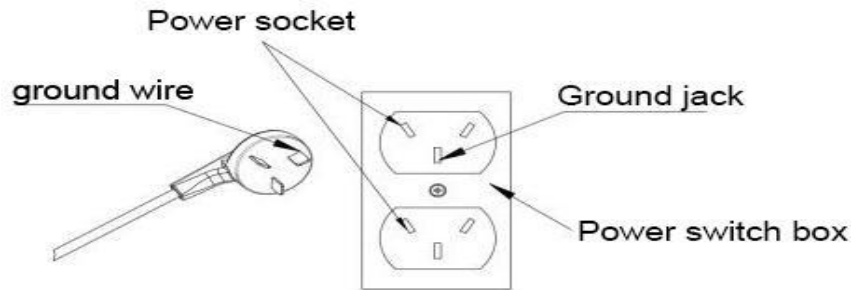

# EXPLODED VIEW

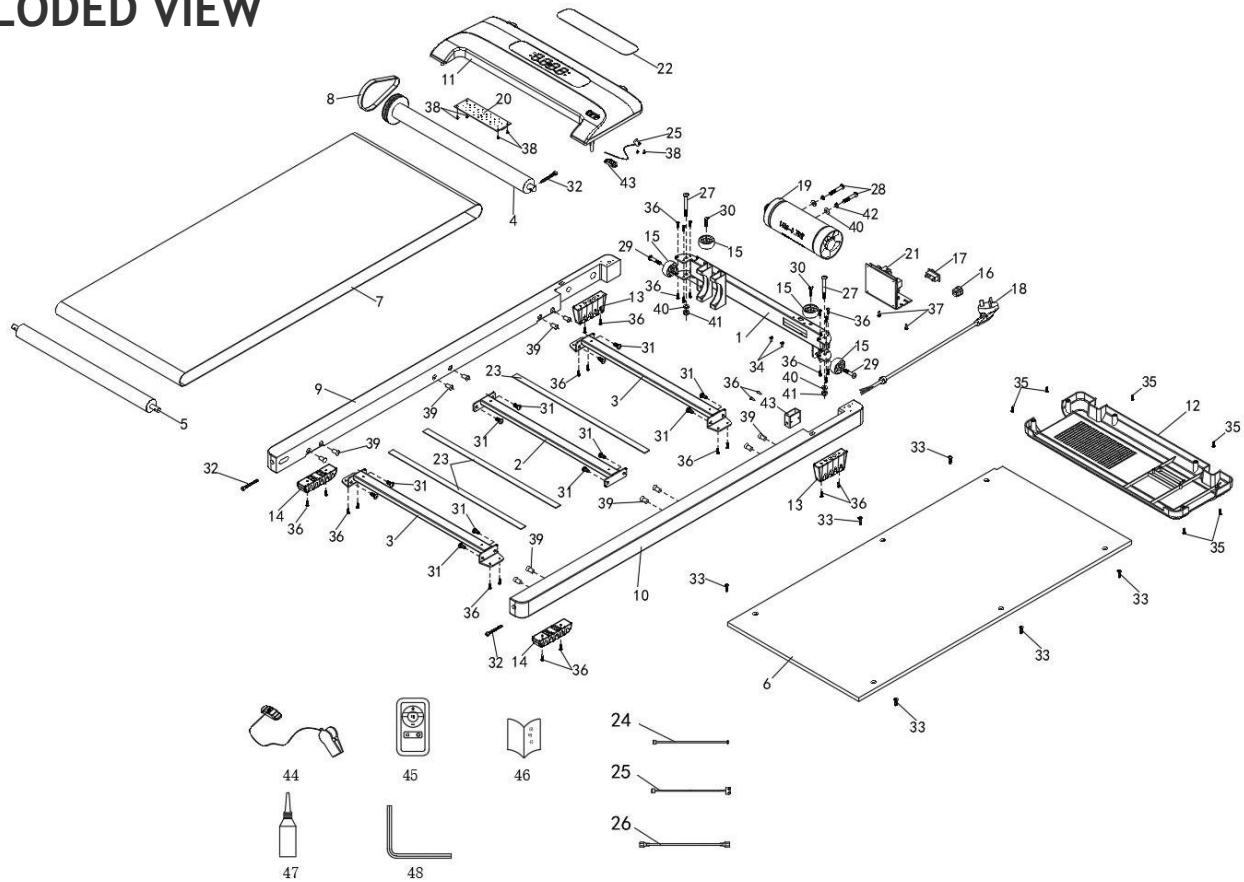

## EXPLOSION DETAILS

NO.	SPARE PARTS NAME	QTY	NO.	SPARE PARTS NAME	QTY
1.	Main frame front transverse tube	1	25.	Line of induction	1
2.	Main frame transverse pipe	1	26.	Power cable	1
3.	Main frame rear transverse tube	2	27.	Cylindrical head hex socket bolt M8*65	2
4.	Front roll	1	28.	Hexagon bolt with half round head M8*50	2
5.	Rear roll	1	29.	Hexagon bolt with half round head M8*35	2
6.	Running board	1	30.	Hexagon bolt with half round head M8*30	2
7.	Running belt	1	31.	Hexagon bolt with half round head M8*16	12
8.	Wedged belt.	1	32.	Cylindrical head hex socket bolt M6*45	3
9.	Left wood border.	1	33.	Countersunk head hex socket screw M6*30	6
10.	Right wood border	1	34.	Cross pan head combination screw M4*10 full teeth (with spring washer, gasket)	2
11.	Motor upper cover	1	35.	Cross pan head tapping screw ST4*19	6
12.	Motor lower cover	1	36.	Cross pan head tapping screw ST4*16	30
13.	Forefoot pad	2	37.	Cross pan head tapping screw ST4*10	2
14.	Back foot pad	2	38.	Cross pan head tapping screw ST3*8	6
15.	Travelling wheel	4	39.	With embedded nut	1
16.	Power cable buckle	1	40.	Flat gasket M8	4
17.	Power switch	1	41.	Lock nut M8	2
18.	Power cord	1	42.	Spring pad M8	2
19.	Motor	1	43.	Roller tube	1
20.	Top control	1	44.	Safety switch	1
21.	Down control	1	45.	Remote control	1
22.	Motor cover surface sticker	1	46.	Manual	1
23.	EVA single side adhesive	3	47.	Silicone oil	1
24.	Communication wire	1	48.	Allen key S5	1



## WARMING UP

It's best to stretch before exercising. Warm muscles stretch more easily, so take 5-10 minutes to warm up. Then stop and stretch as follows - do five times, each leg for 10 seconds or more, and do it again at the end of the exercise.

1. **Stretch down:** bend your knees slightly, bend forward slowly, relax your back and shoulders, and touch your toes with your hands as much as possible. Hold for 10-15 seconds, then relax. Repeat 3 times (see Figure 1).
2. **Hamstring extension:** sit on a clean seat cushion with one leg straight. Put the other leg inward so that it is close to the inside of the extended leg. Try to touch your toes with your hands. Hold for 10-15 seconds, then relax. Repeat for each leg three times (see Figure 2).
3. **Leg and foot tendon extension:** stand on the wall or tree with one foot behind. Keep your hind legs upright with your feet on the ground and lean toward the wall or tree. Hold for 10-15 seconds, then relax. Repeat for each leg three times (see Figure 3).
4. **Quadriceps stretch:** hold your left hand against the wall or table to balance, then extend your right hand backward, grasp the heel of your right foot and slowly pull it toward your hips until you feel the muscles in front of your thighs are tense. Hold for 10-15 seconds, then relax. Repeat for each leg three times (see Figure 4).
5. **Sartorius muscle (muscle in the inner thigh) stretch:** sit with the soles of the feet opposite and the knees facing out. Grab your feet with both hands and pull toward the groin. Hold for 10-15 seconds, then relax. Repeat 3 times (see Figure 5).

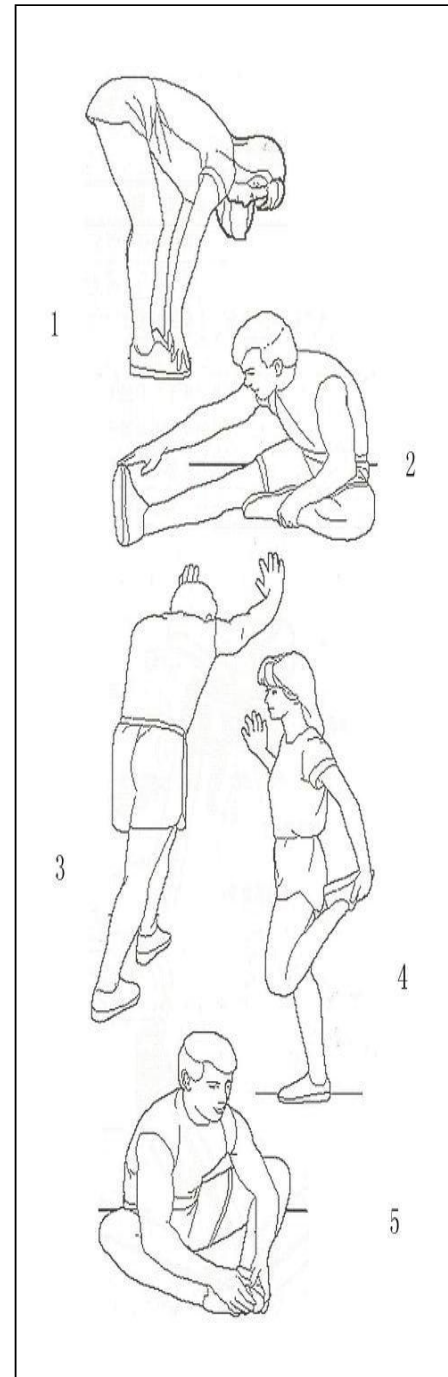

# SAFETY TRAINING MEASURES

## WARM UP STAGE

If you are over 35 years old, or not very healthy, also it's your first time exercise, please consult with your doctor or professional person. Before you use the motorized treadmill, please learn how to control the machine, know well how to start, stop, adjust the speed and so on; don't stand on the machine at this time. After that, you can use the machine. Stand on anti-slip pad both sides and handle the handle bar with your both hands. Keep the machine at the low speed about 1.0-2.0 mile/h, then test the running machine by one foot, after get used to the speed, then you can run on the machine and you can add the speed between 1.9 and 3.1 mile/h. Keep the speed about 10 minutes, then stop the machine.

## EXERCISE STAGE

Learn how to adjust the speed and incline before using. Walk about 0.6 mile at stable velocity and write down the time, it will take you about 15-25 minutes. If walk at 4.8 mile/h, it will take you about 12 minutes in 0.6 mile. If you feel comfortable at the stable velocity, you can add the speed and incline, after 30 minutes, you can have good exercise. Before the walking exercise program, be clear in your mind: do not rush, this exercise is for your own lifetime health, not overnight magic.

## EXERCISE INTENSITY

Shortcuts - A 15-20 minute workout is a great way to save time. Warm up at the speed 1.9 mile/h in 2 minutes, then add the speed to 3.3 mile/h and keep walking in 2 minutes, then add to 3.6 mile/h and walk in 2 minutes. After that, add up 0.2 mile/h in each 2 minutes, Until you feel that your breathing is faster but not difficult. Keep exercising at this speed and reduce your speed by 0.2 mile/h if you feel breathless. At the end, allow 4 minutes to slow down. If you find it difficult to increase the intensity of your exercise by increasing the speed, use a slow increase in the incline. A slight increase in the incline will greatly increase the intensity of the exercise. Calorie burning---the best effective way Warm-up for 5mints by the velocity: 2.5-3.0 mile/h, then slowly increase the speed by 0.2 mile/h/2Mints ,until up to the stable speed which you feel is comfortable for 45Mints. For improving the intensity of movement, you can maintain the speed during 1H of TV program, then increase the speed by 0.2 mile/h each Advertisement interval time, after that return to the original speed . You can acquaint the best efficiency of workout for calorie burning during the advertisement time and subsequent heart frequency increasing time. Finally, you should slow down the speed step by step for 4Mints.

## EXERCISE FREQUENCY

The cycle time: 3-5times/Week, 15-60mints/Times. Make up the schedule of workout scientific, not only for your hobby. You can control the running intensity through adjusting the velocity and incline of treadmill. We suggest that you don't set the incline at first; improve the incline is the effective way to strengthen the exercise's intensity.

## SAFETY TRAINING MEASURES

Consult with your physician or health professional before starting your workout. The professional people can help you make up the suitable exercise time-chart according to your age and health condition; determine the velocity of movement, the intensity of exercise. Please stop at once, if you feel chest tightness, chest pain, irregular heartbeat, breath difficulty, dizziness or other discomfort during exercise. You should consult with your physician or health professional as keep going. You can choose the normal walking speed or the jogging speed, if you always take workout with treadmill. If you don't have enough experiences or confirm the testing velocity, you can follow the instruction:

**SPEED 0.6-1.9 Mile/H A PERSON OF POOR CONSTITUTION**

**SPEED 1.9-2.5 Mile/H A SEDENTARY OR SEDENTARY PERSON**

**SPEED 2.5-3.1 Mile/H CONSTANT SPEED WALKER**

**SPEED 3.1-3.7 Mile/H FAST WALKERS**

**PLEASE NOTE:** A speed of less than or equal to 3.7 mile/h is appropriate for walkers.

## PRODUCT MAINTENANCE

**WARNING:** Before cleaning or maintaining the product, be sure to remove the power plug of the electric treadmill.

**CLEANING:** Comprehensive cleaning will extend the life of the electric treadmill.

Remove dust regularly to keep parts clean. Be sure to clean the exposed parts on both sides of the running belt, which will reduce the accumulation of impurities under the running belt. Make sure the shoes are clean and avoid carrying foreign objects under the running belt to wear the running board and belt. The surface of the running belt should be cleaned with a wet cloth stained with soap. Please be careful not to splash water on the electrical components and under the running belt.

**WARNING:** be sure to remove the power plug of the electric treadmill before moving the motor protective cover. Open the motor protection cover at least once a year to clean the motor

## SPECIAL LUBRICATING OIL FOR RUNNING BELT AND ELECTRIC RUNNING

The running board and running belt of this electric treadmill have been precoated with lubricating oil. The friction force between the running belt and the running board has a great influence on the service life and performance of the electric treadmill, so lubricating oil should be applied regularly. We recommend regular inspection of the board surface. If the board is damaged, please contact our customer service center. We suggest to apply lubricating oil between the running belt and running board of the electric treadmill according to the following schedule: (usage as shown in the figure below)

**LIGHTWEIGHT USERS (LESS THAN 3 HOURS PER WEEK) ONCE A YEAR;**  
**MODERATE USERS (3-5 HOURS PER WEEK) ONCE EVERY 6 MONTHS;**  
**HEAVYWEIGHT USERS (MORE THAN 5 HOURS A WEEK) ONCE EVERY 3 MONTHS.**

We suggest that you purchase lubricants from your local distributor or contact us directly.

Note: any other maintenance should be operated by professionals.

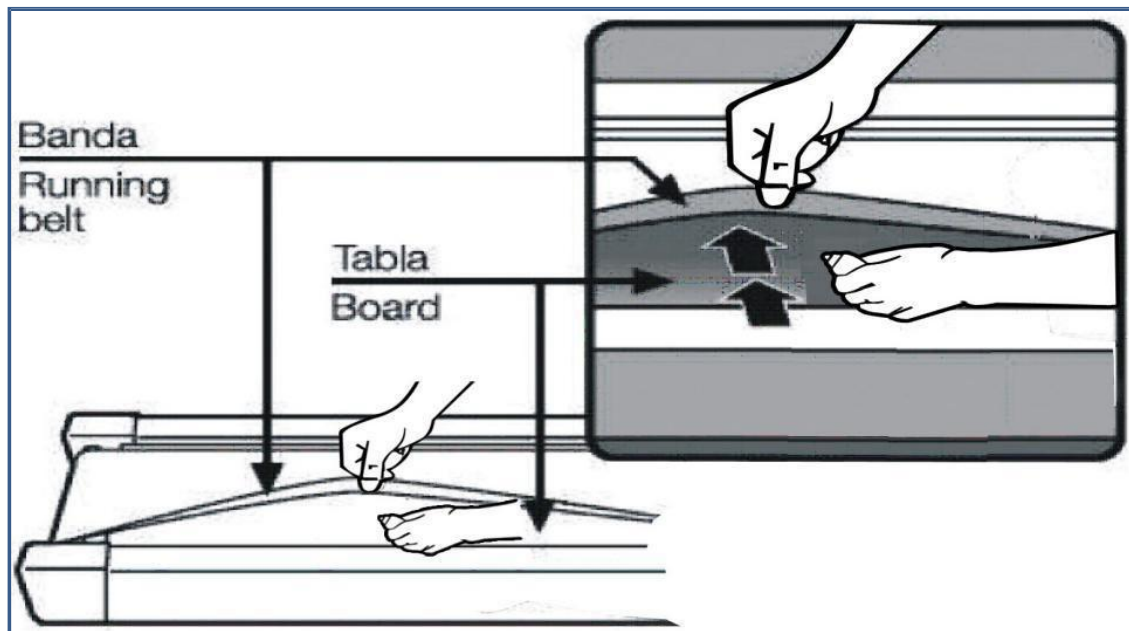

## RUNNING BELT ADJUSTMENT

1. In order to better maintain your electric treadmill and prolong its service life, it is recommended that you turn off the power supply after 1.5 hours of continuous use and let the machine rest for 10 minutes before use.
2. If the running belt is too loose, it will slip during running; if it is too tight, it may reduce the motor performance and aggravate the wear of drum and running belt. When the tension of the running belt is appropriate, the two sides of the running belt can be lifted away from the running board by hand about 50-75mm.

### BELT ADJUSTMENT

Put the electric treadmill on a level surface. Run the electric treadmill at a speed of about 3.72-5mph and observe the deviation of the running belt.

If the running belt deviates to the right, pull out the safety lock and power switch, rotate the right adjusting bolt 1 / 4 turn clockwise, insert the power switch and safety lock, make the treadmill run, and observe the deviation of running belt. Repeat until the running belt is centered. Figure A.

If the running belt deviates to the left, pull out the safety lock and power switch, rotate the left adjusting bolt 1 / 4 turn clockwise, insert the power switch and safety lock, make the treadmill run, and observe the deviation of running belt. Repeat until the running belt is centered. Figure.

After the above adjustment or use for a period of time, the running belt will gradually relax and need to be adjusted. Pull out the safety lock and power switch. At

the same time, rotate the adjusting bolts on both sides clockwise for 1 / 4 turn. Insert the power switch and safety lock to make the treadmill run. Then stand on the running belt to confirm the tightness. Repeat the above steps until the belt is moderately tight. Figure C

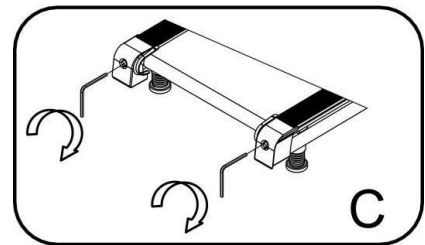
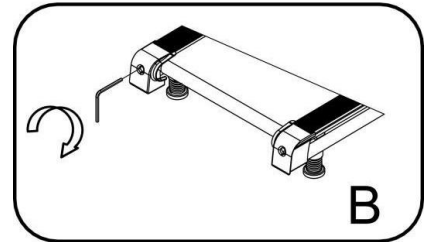
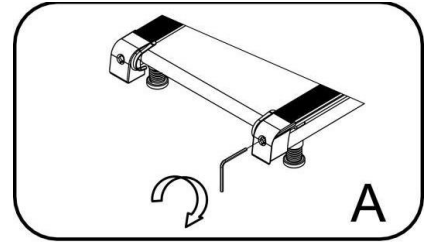

# YD6451 OPERATION GUIDE

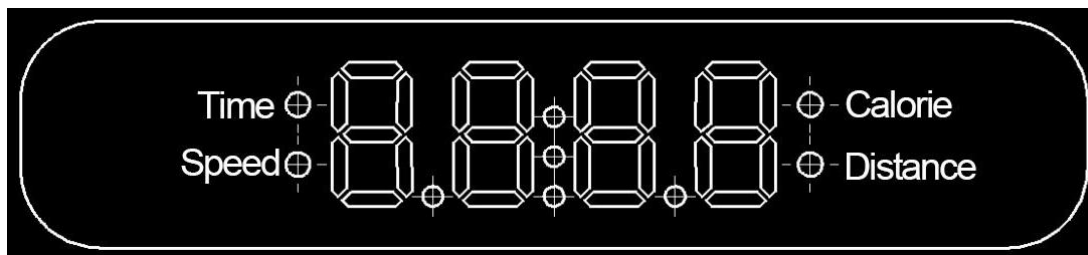





## I. WINDOW INSTRUCTIONS:

“TIME/SPEED/CALORIES/DISTANCE”Window: No key operation 5 seconds cycle switch window.

- (1) When the exercise time is displayed, the forward timing is from 0:00-99:59, and the timing is stopped to the maximum treadmill; The countdown decreases from the set time (the maximum is set to 99 minutes, and the mode of displaying minutes and seconds is set, for example, "99:00") to zero. When the countdown reaches 0:00, the treadmill slows down smoothly to stop running and displays "End", and enters the standby state 5 seconds after the complete stop.
- (2) When the speed is displayed, the speed display range is 0.6-3.7 Mile/h
- (3) When the calories are displayed, it indicates the value of calories consumed by the exerciter, and the positive count is from 0.0-999, and the overflow is cleared to zero. When counting in reverse, it will count backwards from the set value to 0. When counting backwards to 0, the treadmill will slow down smoothly to stop running and display "End", and enter the standby state 5 seconds after completely stopping;
- (4) When the distance is displayed, the forward count is from 0.0-62.1, and the overflow is cleared to zero. The reverse count decreases from the set value to 0. When the reverse count reaches 0, the treadmill slows down smoothly to stop running and enters the standby state 5 seconds after the display of "End" stops completely.

## II. KEY DESCRIPTION (REMOTE CONTROL) :

1. “”start // pause: When the power is on and the safety lock is on standby, press this key, the system will enter the 3-second countdown, and the treadmill will start running at a speed of 0.6 Mile/h. Press this key to stop the treadmill running during operation.
2. “” “” Speed plus or minus key: Press the deceleration key will reduce the running speed of the treadmill, press the acceleration key will increase the running speed of the treadmill; Its adjustment amplitude value is 0.06 Mile/ time, and it automatically increases or decreases when held for more than 0.5 seconds.
3. “”Stop button. Press the stop button in the running state to stop and reset the treadmill.
4. “”Mode key: The standby state can switch the backward counting mode; The display window can be switched when running.
5. Safety lock: at any time unplug the safety lock, quickly stop the treadmill, put the safety lock reset.

## III. QUICK START:

1. Open the power switch, the safety lock is in the effective state.
2. Press the "start" button, the system enters the 3-second countdown, the buzzer sounds, and the window displays the countdown number. After the 3-second countdown, the treadmill starts to run at a speed of 0.6 Mile/h.
3. After starting, you can adjust the speed of the treadmill according to the need to use the speed plus or minus key.

## V. OPERATION DURING MOVEMENT:

1. Press "start" to stop running the treadmill.
2. Press the stop button and the runner will slow down to stop running.
3. Press the speed plus or minus key. Adjust the treadmill speed.

## V. MANUAL MODE:

1. "MODE" is the mode selection key: Press this key to select "0.0", "15:00", "1.00", and "50" (" 0.0" is the system default operating mode, " 15:00 " is the time counting mode, " 0.6 " is the distance counting mode, and " 50.0 " is the calorie counting mode). The speed plus or minus key can be used to set the relevant backcount value when selecting the backcount mode. After setting, press "START" to start the treadmill.
2. In the standby mode, directly press the "start" button, the treadmill at a speed of 0.6 mile/h. Other Windows start counting forward from 0. Press speed+ and speed - to change the speed.
3. In the standby mode, press Mode to enter the time counting mode. The Time window displays 15:00 and blinks. Press speed+ and speed - to set the motion time, which ranges from 5:00 to 99:00.
4. In the time counting mode, press the "mode" key to enter the distance counting mode, and the "dist" (distance) window displays "1.00" and blinks. Press the "speed+" and "speed -" keys to set the movement distance, and the range of distance setting is 0.3-62.1.
5. In the distance reversion mode, press "Mode" to enter the calorie reversion mode, and the "cal" window displays "50.0" and blinks. Press "speed+" and "speed -" to set calories. The calorie setting range

**VI. DISPLAY RANGE OF EACH VALUE:**

<b>PARAMETER SETTING</b>	<b>INCEPTION</b>	<b>SET INITIAL VALUE</b>	<b>SETTING RANGE</b>	<b>DISPLAY RANGE</b>
Time (min: SEC)	0	15:00	5:00-99:00	0:00-99:59
Speed (Mile/h)	0.0	0.6	0.6-3.7	0.6-3.7
Distance (mile)	0.0	0.6	0.3-62.1	0.3-62.1
Calories (kcal)	0	50	10-999	0-999

**VII. SAFETY KEY FUNCTION:**

In any state, pulling off the safety lock can stop the running machine urgently. When the treadmill stops emergency stop, all windows display "-----", and the bee sounder emits 3 alarms of "BB"; You cannot perform any other operations outside. After the security lock is re -positioned, the treadmill will re -enter the standby state and wait for the instruction to enter instructions.

**VIII. POWER-SAVING MODE:**

This system has a power -saving function. If there is no key instruction input in 10 minutes in the standby state, the system enters the power saving mode, automatically turn off the display, and press any key to regain the system.

**IX. TURN OFF:**

At any time, you can turn off the treadmill by turning off the power switch, which will not damage the treadmill.

**X. NOTE:**

1. Check whether the power supply is loaded before exercise; check whether the safety lock is effective.
2. During the exercise, abnormal conditions can be pulled off, and the running opportunities can be slowed down to stop; then put in a security lock, equipment reset, and wait for instructions.
3. If you have any questions, please contact the dealer. Non -professional, please do not try to disassemble or repair to avoid damage to equipment.



#### XI. TREADMILL SIMPLE FAULT EXCLUSION METHOD:

1. After the power supply is turned on, there is no display of the electronic meter
  - A. First check whether the overload protector jumps away, if you jump away and press it;
  - B. Check the power cord on the power switch, overload protector and drive to ensure that the connection is good;
  - C. Check whether the power cord of the electronic meter to the drive is inserted. Remove the pillar to check the electronic meter to each section of the drive cable of the drive to ensure that each wire core is completely inserted, or the communication power line is poor (damaged or broken or broken. ), Need to be re -connected or replaced.
  
2. After the power is powered, the electronic meter displays "E01"-----communication failure (the drive does not receive the electronic meter signal); the electronic watch display "E13"-----Signal)
  - A. The electronic meter is blocked by the communication of the driver. Check at each section of the electronic meter to the driver's communication line to ensure that each wire core is completely inserted; check whether the connection between the electronic meter and the driver is damaged, and replace the communication cable.
  - B. The communication line on the electronic meter is abnormal, the component is damaged, and the electronic watch is replaced;
  - C. Drive signal line failure, replace the drive.
  
3. If the electronic watch is displayed "E02"----- Explosion-proof or motor abnormalities
  - A. Check whether the motor line is connected, and connect the motor line again. If it will not change the motor;
  - B. Check whether the controller has a odor, IGBT is cut into short circuit, and the driver is replaced;
  - C. Check whether the voltage of the power supply is lower than 50%of the normal voltage, please use the correct voltage specifications to re -test;
  
4. After startup, the electronic watch is displayed "E03"----- no sensing signal
  - A. If the motor starts for 5-8 seconds, the "E03" shows that the speed sensor signal is not detected. Check whether the sensor plug is not inserted or the magnetic sensor is ruptured or damaged. Insert it or replace the magnetic sensor.
  - B. The sensor signal line is abnormal in control, and the driver is replaced;
  
5. After startup, the electronic watch is displayed "E04"
  - A. Check whether the signal line of Yangsheng Motor is inserted, and re -insert the signal line connector to make it reliable;
  - B. Check whether the Yangsheng Motor AC cable is plugged in correctly.
  - C. Check whether the connection line of the motor is damaged, replace the connection line or raise the motor;
  - D. Replace the drive;
  - E. After all the inspection is checked, press the learning key on the driver to re-learn again.

6. After running, the electronic watch shows "E05"-----Overcurrent protection
- A. The possible reason is that the current exceeds that the current is too large, the system is self -protection, just restart;
  - B. A certain part of the treadmill is stuck, resulting in the motor that cannot be transferred, the load is too heavy, the current is too large, the system is self-protection, and the treadmill can be adjusted to reorganize or increase the lubricant.
  - C. Check whether the motor has a stream or burnt odor when running, and change the motor;
  - D. Check whether the driver is burnt and replace the driver;
7. If the electronic watch is displayed "E06" after run The A motor line is not connected to the plug -in wire;  
B motor internally open, replace the motor; C motor is empty, the current is wrong after hours, please install the machine test;
8. If the electronic watch is displayed "E08"----- storage 24C02 error (takes the 24C02 drive)
- A storage IC is not inserted (non -switching power supply), re -inserts to the IC seat, pay attention to the position of the PIN1 foot;
  - B storage IC damage, or poor related routes, replace the storage IC, or change the drive;
9. If the electronic watch is displayed "E10" after running----- usually short circuit in an instantaneous motor
- A driver's torque is too large, adjust the torque potentiometer until the appropriate position;
  - B motor in the short circuit, replace the motor;
  - C to kill the transmission site, adjust the transmission site, or add lubricating oil;