

ROVECONCEPTS

kaye COLLECTION



**NUVO MODULAR SOFA
ASSEMBLY INSTRUCTIONS**

HARDWARE

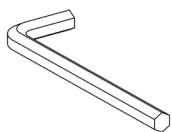

A

x1
M4

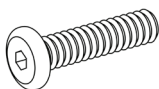

B

x30
M6*25

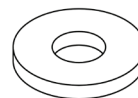

C

x30
Ø15*1 - Ø6.5

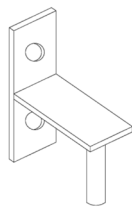

D

x15

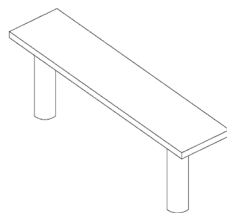

E

x12

STEP 1

Install B on the sofa.

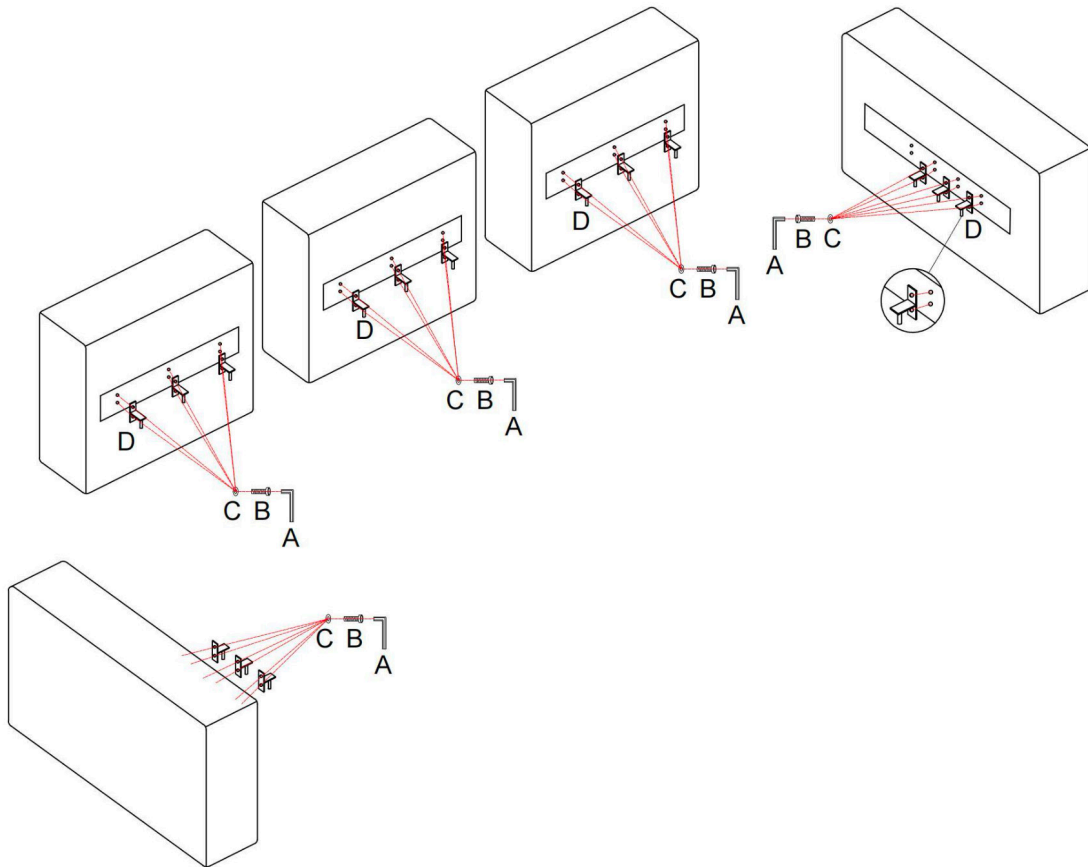

STEP 2

Back and armrest buckle together with seat.

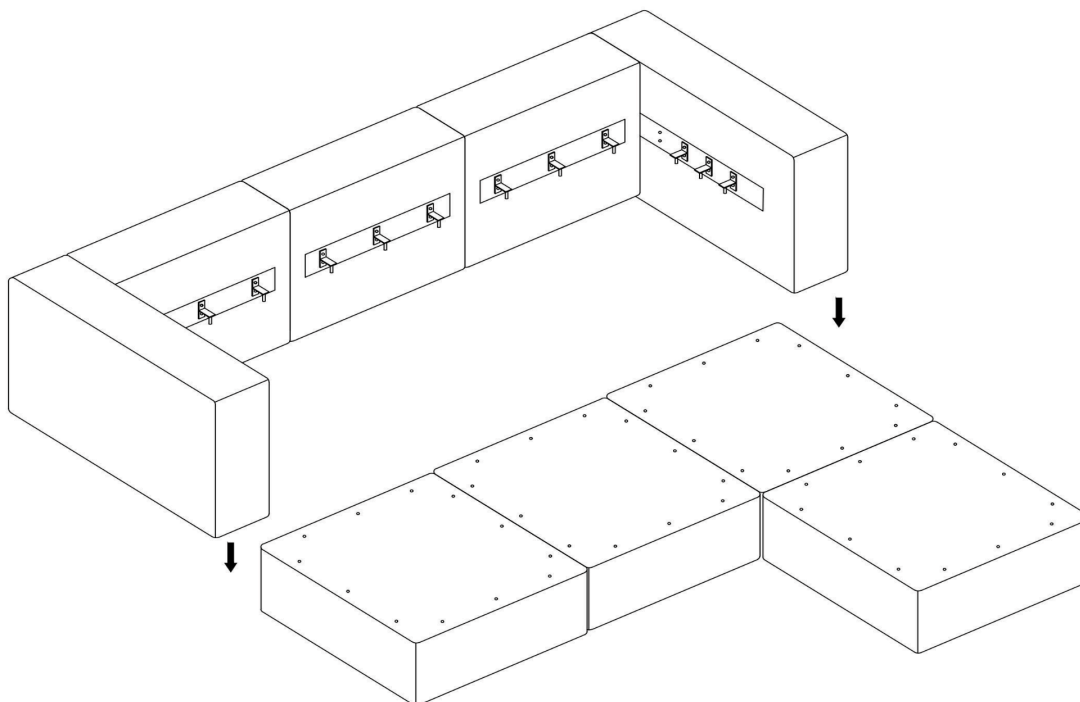

STEP 3

Connect each seat with E.

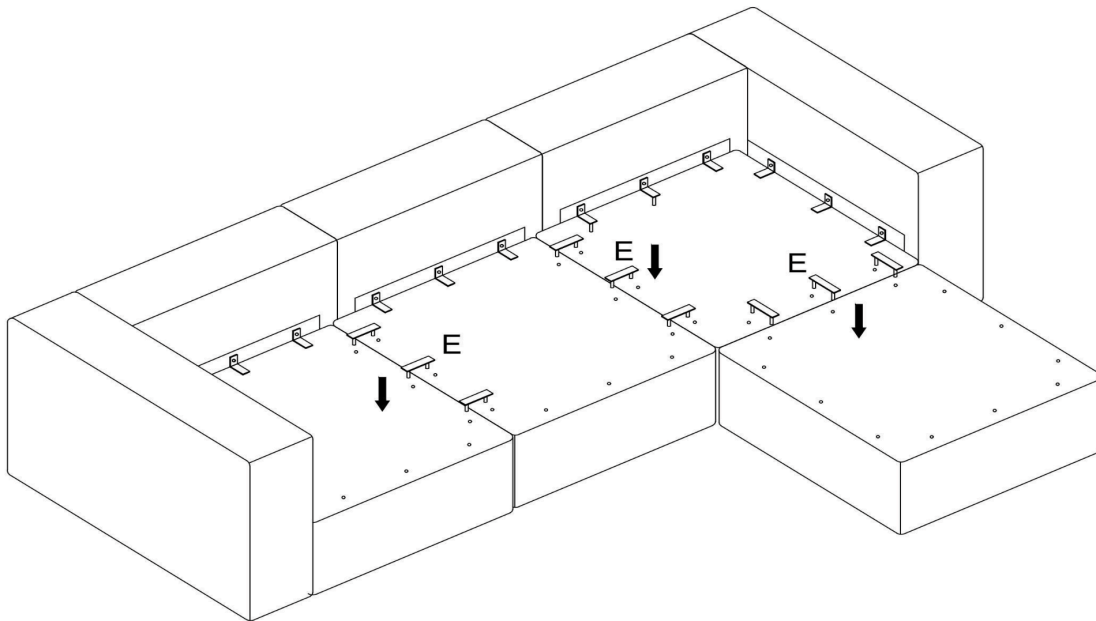

STEP 4

Complete

